

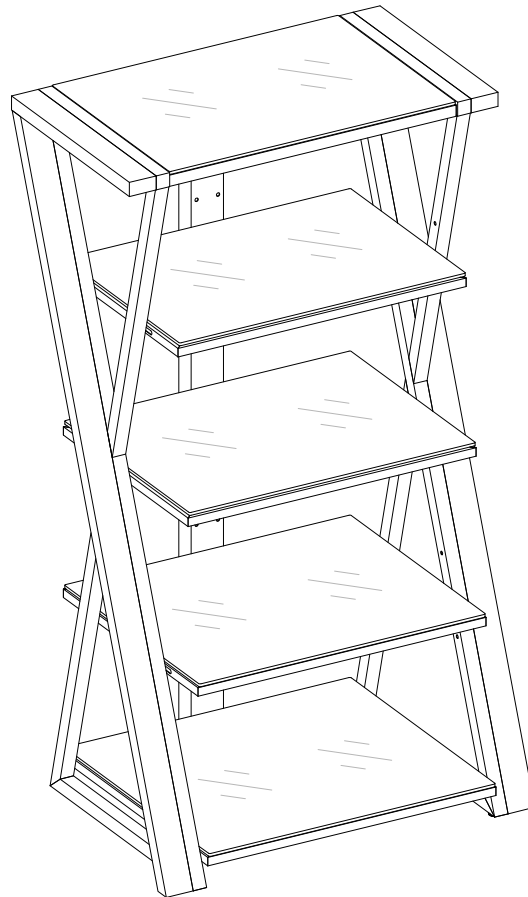

WHALEN®

LOT NUMBER: _____
DATE PURCHASED: __/__/__

Audio Video Tower Stock # AVT-22E



ADULT ASSEMBLY REQUIRED

If you have any questions regarding assembly or if parts are missing, DO NOT return this item to the store where it was purchased. Please call our customer service number and have your instructions and parts list ready to provide the model name, part name or factory number:

1-866-942-5362

Pacific Standard Time: 8:30 a.m. - 4:30 p.m., Monday - Friday

Or visit our web site 24 hours a day, 7 days a week for product assistance at

www.whalenstyle.com

Or e-mail your request to parts@whalenfurniture.com

**THIS INSTRUCTION BOOKLET CONTAINS IMPORTANT SAFETY INFORMATION.
PLEASE READ AND KEEP FOR FUTURE REFERENCE.**

Whalen Furniture Manufacturing

Page 1

Factory No. 10944

Date: 2015-04-07 Rev. 1 Factory: FOCIDI

MAXIMUM RECOMMENDED WEIGHT LOADS

MANUFACTURER: Whalen Furniture Manufacturing
CATALOG: Audio Video Tower (AVT-22E)
DATE OF MANUFACTURE: April 2015
MADE IN CHINA

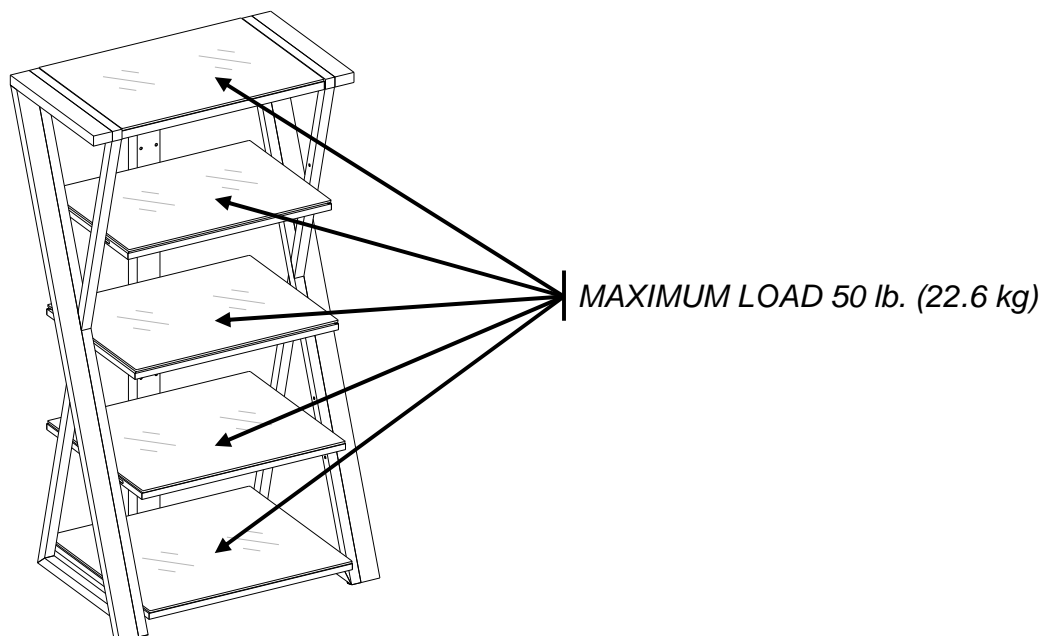

⚠ WARNING THIS UNIT IS INTENDED FOR USE ONLY WITH THE MAXIMUM WEIGHTS INDICATED. USE WITH LOAD HEAVIER THAN THE MAXIMUM WEIGHTS INDICATED MAY RESULT IN INSTABILITY, CAUSING POSSIBLE INJURY.

GENERAL INFORMATION, TIPS and TRICKS

1. Please read the Assembly Instructions prior to assembling this product.
2. Remove all hardware from the box and sort by size.
3. Check to see that all hardware and parts are present BEFORE assembling.
4. Ask a friend to assist you with the assembly of this furniture.
5. To avoid damage, assemble the product on a sturdy, level and protective surface.
6. Please wait until all steps are completed before fully tightening bolts.
7. Make sure all bolts are tightly fastened before the unit is used.

This product is sold with one set of Tipping Restraint Hardware Kit. You must install the Tipping Restraint Hardware between the wall and the unit to prevent any accidents or damages. When properly installed, this restraint can provide protection against the unexpected tipping of the unit due to small tremors, bumps or climbing. The restraint is only a deterrent and is not a substitute for proper adult supervision. Use of tip-over restraints may only reduce, but not eliminate, the risk of tip-over.

Please call for replacement parts or assistance: [1-866-942-5362](tel:1-866-942-5362)

Parts and Hardware List

Please read completely through the instructions and verify that all listed parts and hardware are present before beginning assembly.

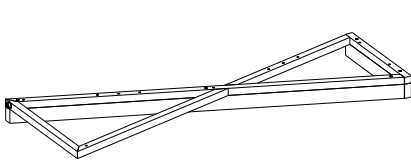

A- Left Side Frame (1)

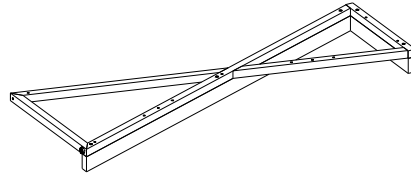

B- Right Side Frame (1)

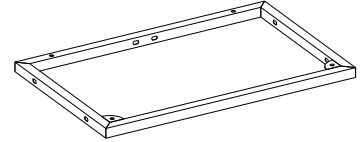

C- Top Shelf Frame (1)

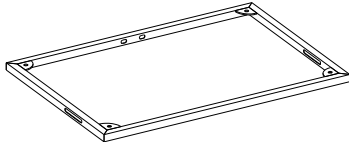

D- Middle Upper Shelf Frame (1)

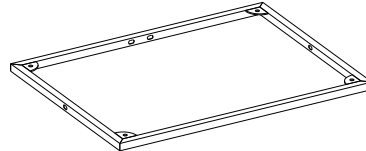

E- Middle Shelf Frame (1)

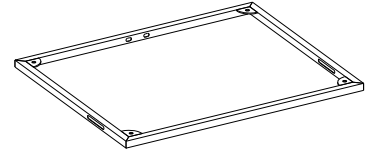

F- Middle Lower Shelf Frame (1)

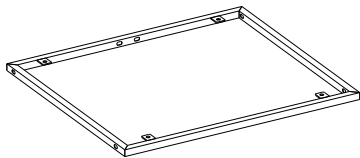

G- Bottom Shelf Frame (1)

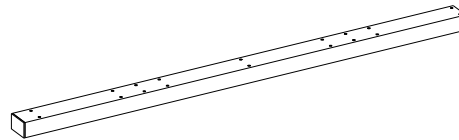

H- Spine (1)

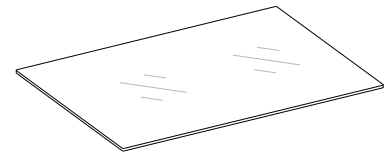

I- Top Glass (1)

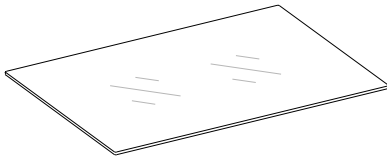

J- Middle Upper Glass Shelf (1)

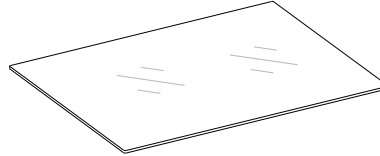

K- Middle Glass Shelf (1)

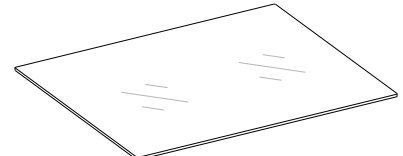

L- Middle Lower Glass Shelf (1)

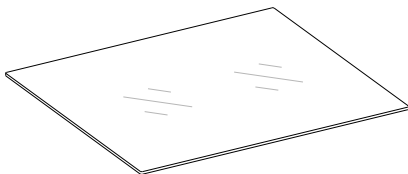

M- Bottom Glass Shelf (1)

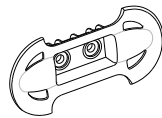

N- Cable Wheel (2)

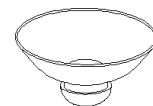

(1) Suction Cup (20+1 extra)

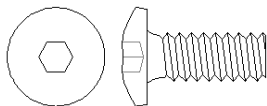

(2) 5/8" Bolt (4+1 extra)

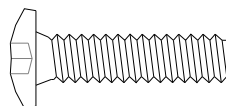

(3) 1" Bolt (18+1 extra)

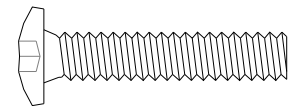

(4) 1-1/4" Bolt (6+1 extra)



(5) Lock Washer
(6+1 extra)

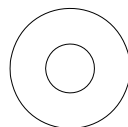

(6) Flat Washer
(6+1 extra)

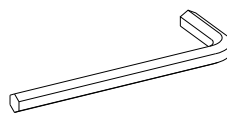

4 mm Allen Wrench
(2)

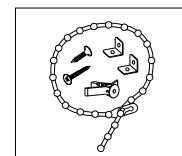

Tipping Restraint Hardware Kit (1)
(Inside Plastic Bag)

Tools required: Allen Wrench (provided) and Phillips screwdriver (not provided).

Please call for replacement parts or assistance: 1-866-942-5362

Assembly Instructions

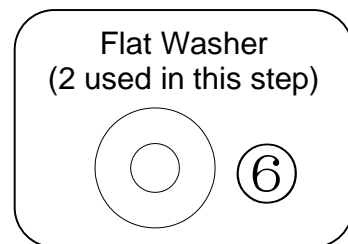
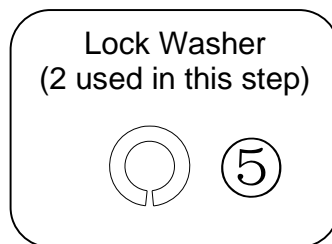
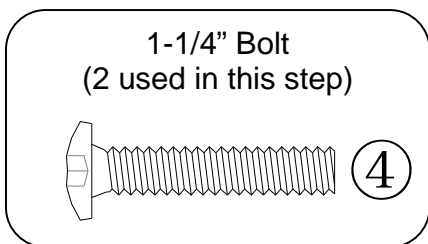
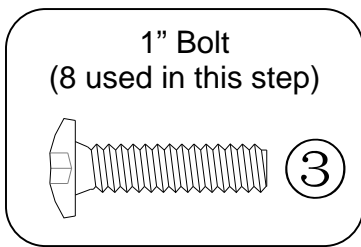
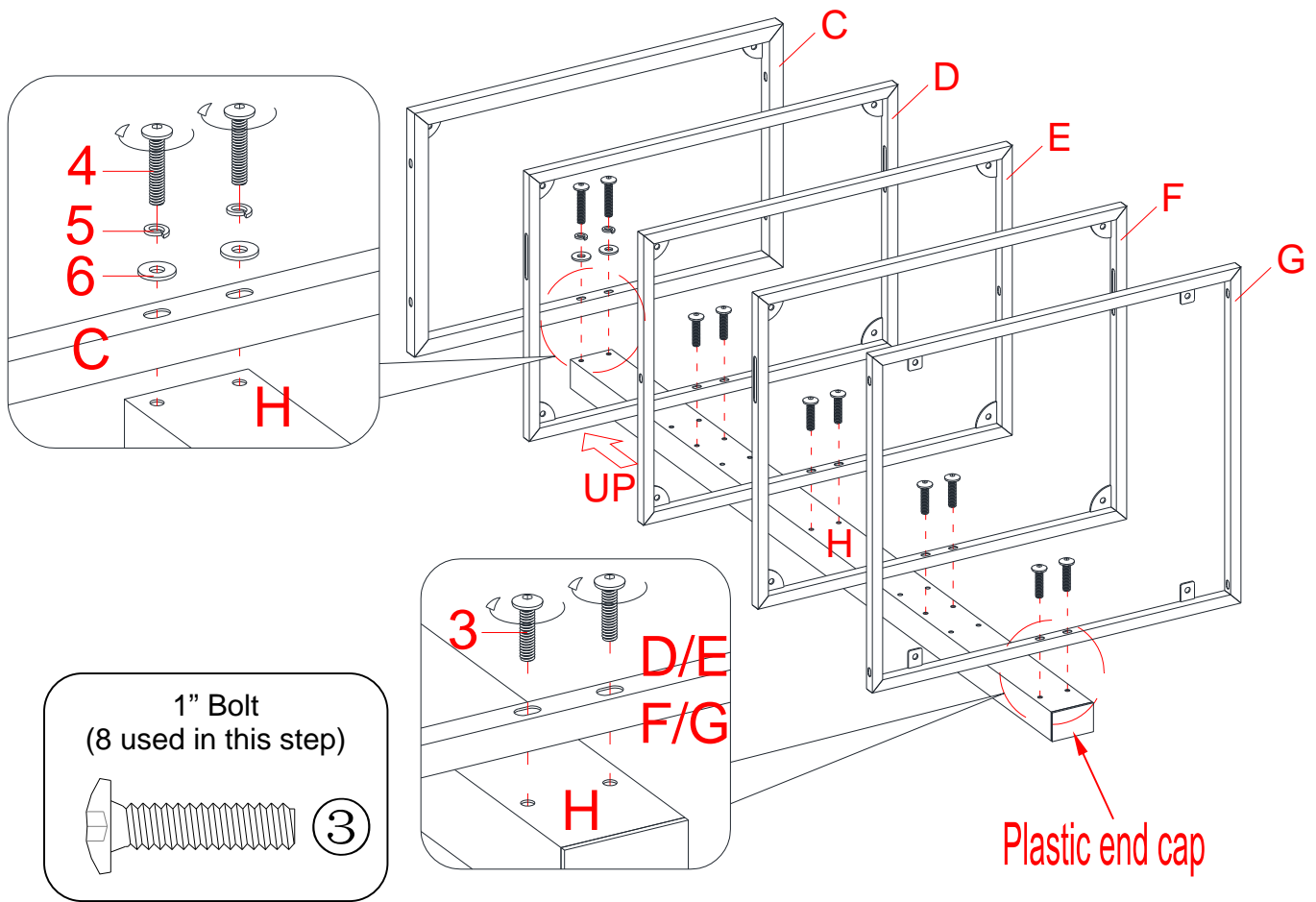

NOTE: Please do not fully tighten all bolts until you finish assembling all parts. Once assembled, go back and fully tighten all bolts. This will make the assembly easier.

1. Unpack the unit and confirm that you have all the hardware and required parts.
2. Locate the Spine (H) and set back face down on a scratch free surface, as shown.
3. Align and attach the Shelf Frames (C, D, E, F and G) to the Spine (H) respectively, as shown above. Make sure that the inside corner plates on the Shelf Frames will face up when the unit is turned upright.

Please call for replacement parts or assistance: 1-866-942-5362

Assembly Instructions

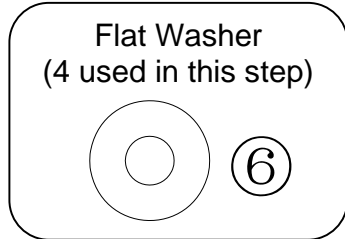
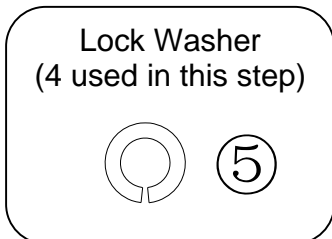
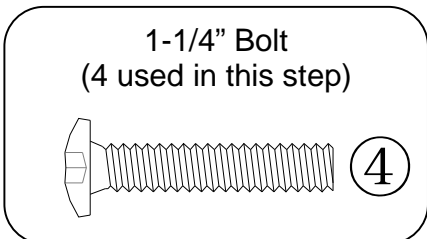
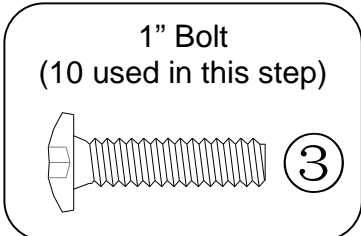
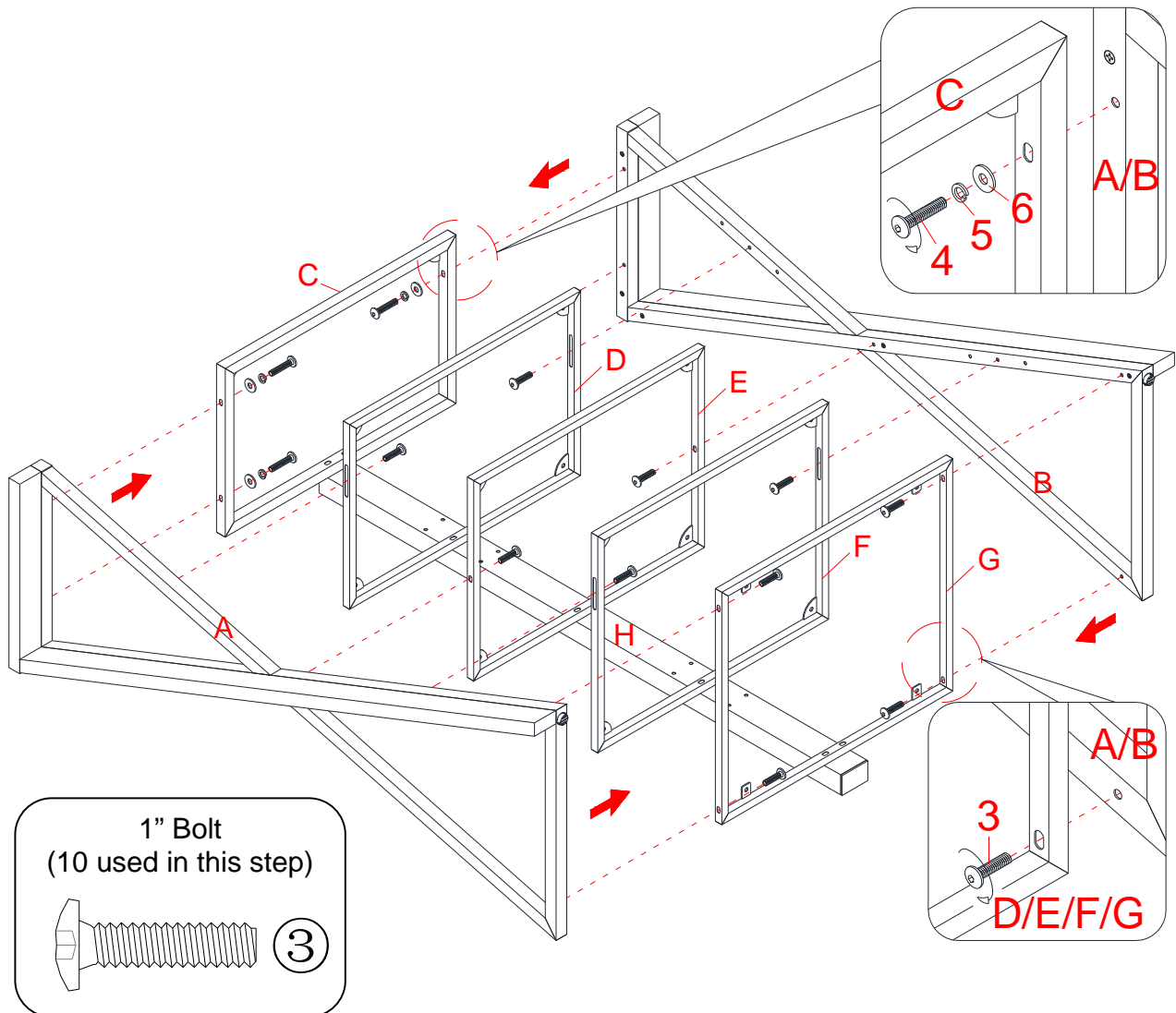

4. Align and attach the Left Side Frame (A) to the Shelf Frames (C, D, E, F and G), as shown above. **DO NOT** tighten the bolts.
5. Repeat the same procedure to attach the Right Side Frame (B) at the opposite end.
6. Go back and tighten all the bolts. Ask for assistance to stand the unit upright.

Please call for replacement parts or assistance: 1-866-942-5362

Assembly Instructions

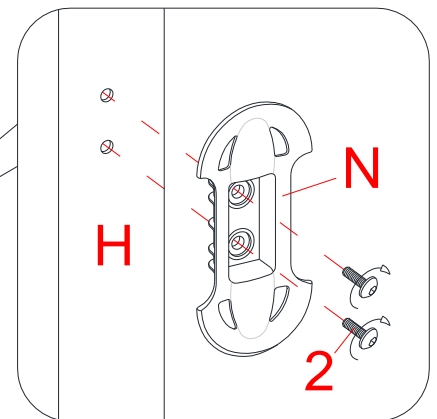
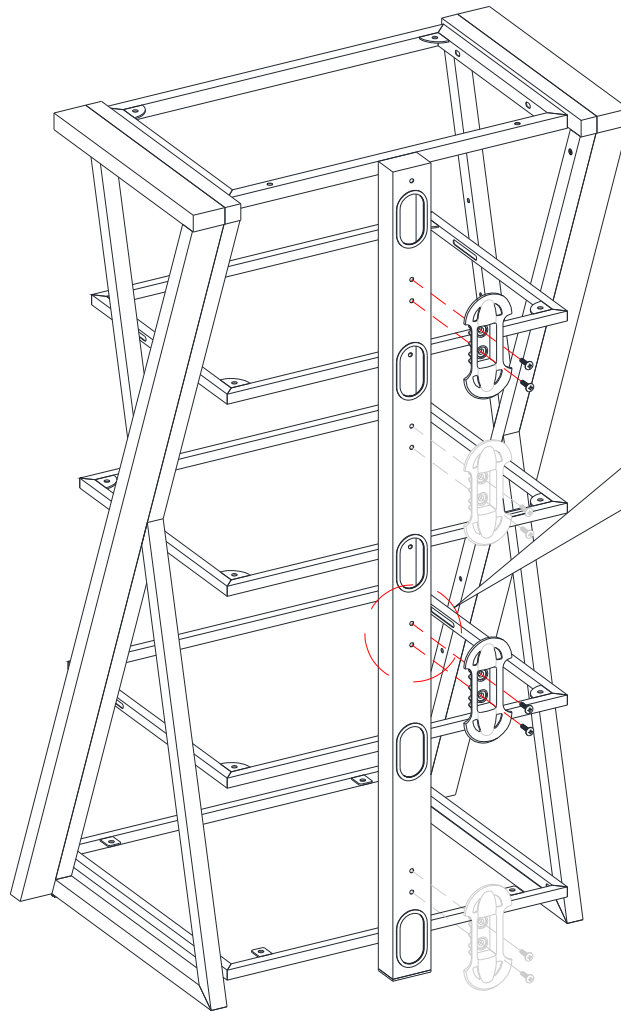
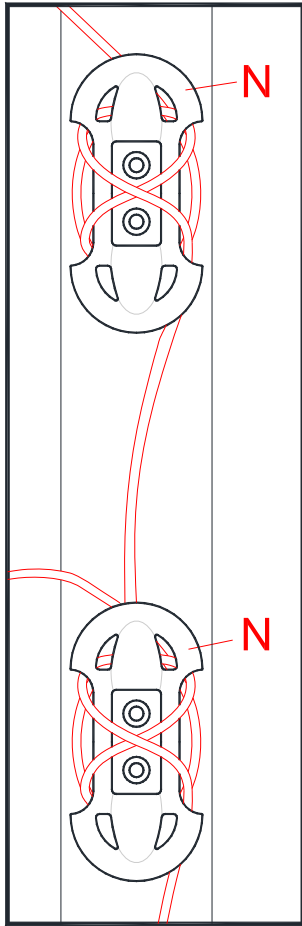

Back view

5/8" Bolt
(4 used in this step)

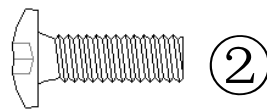

7. Attach 2 Cable Wheels (N) to the backside of the Spine (H) and tighten with the enclosed Allen wrench.
8. The Cable Wheels allow you to organize, route and separate your component cords and cables to minimize tangling and signal interference.

Please call for replacement parts or assistance: 1-866-942-5362

Assembly Instructions

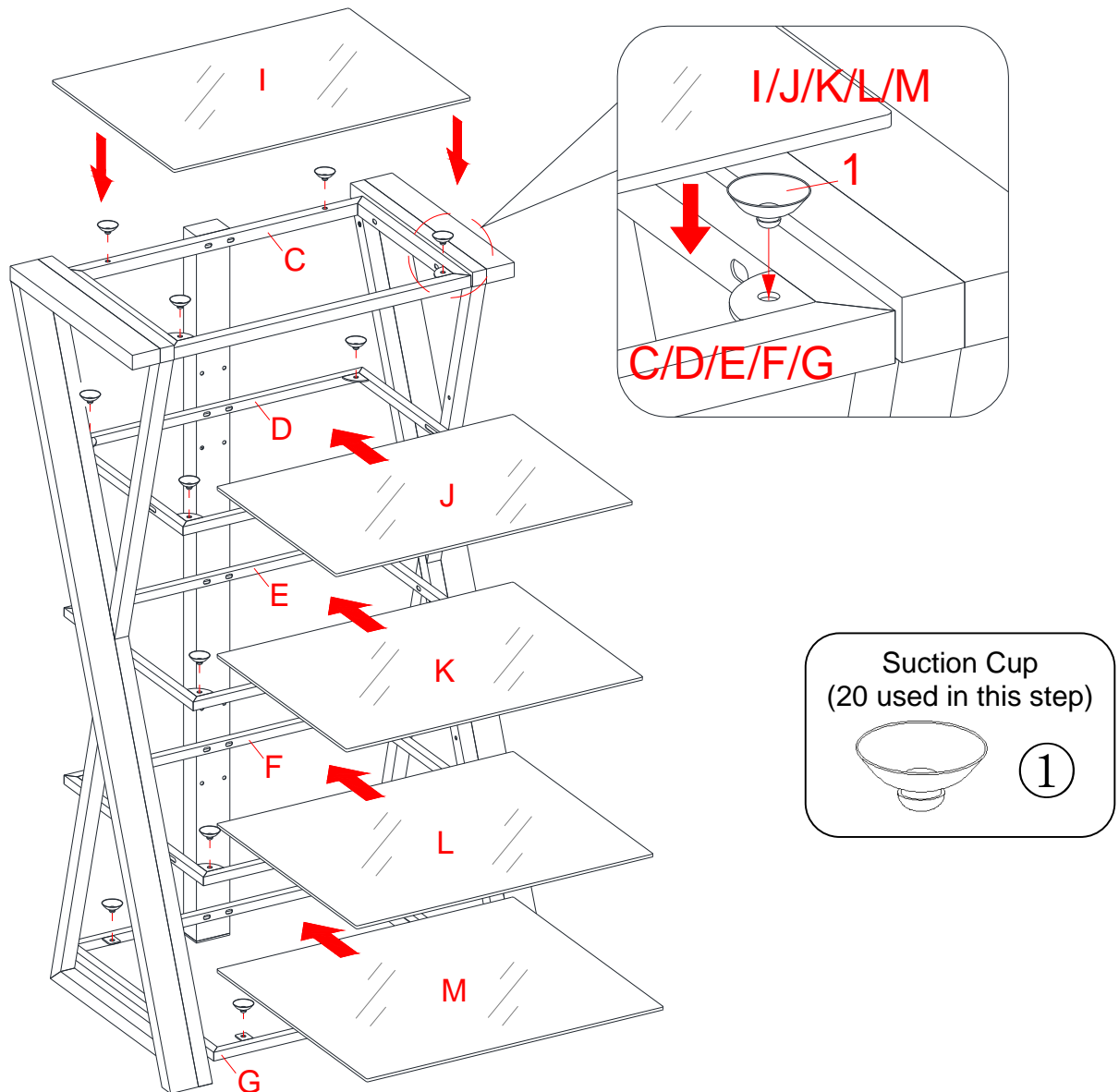

9. Put the Suction Cups (1) firmly into the top holes and the inside corner plates on the Shelf Frames (C, D, E, F and G).

TIP: If a suction cup resists insertion, try pressing down on the middle of the cup with the Allen Wrench while twisting it clockwise into the hole.

10. Place the Glass Shelves (I, J, K, L and M) in place starting with the Bottom Glass Shelf (M). Make sure that the glass shelf is properly centered and the black side of glass shelf is down. Push each glass shelf all the way back against the Spine.

NOTE: If a glass shelf is scratched, you can minimize the damage by using a BLACK marker and filling in scratched area from underneath.

Please call for replacement parts or assistance: 1-866-942-5362

Assembly Instructions

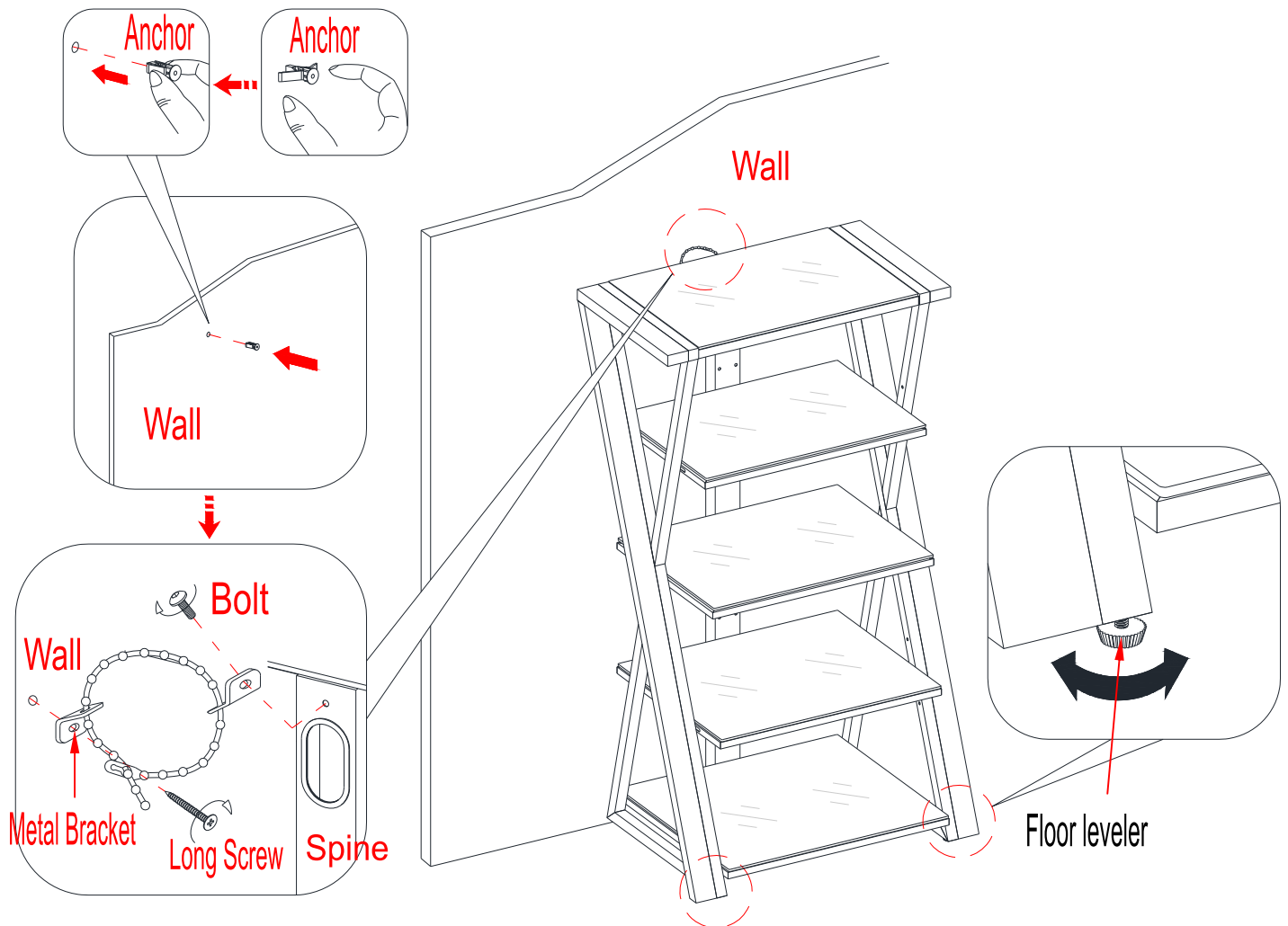

Tools required: Allen wrench (provided), Phillips screwdriver, mallet, power drill, and 3/8" drill bit.

11. Position the assembled tower at the desired location against a wall. If necessary, adjust the pre-attached Floor Levelers on the bottom front of the side frames (A and B) to level the unit.
12. Now, follow the instructions printed on the plastic bag containing the Tipping Restraint Hardware to attach the tip-over restraint to the Spine (H) and the wall.

NOTE: Young children can be seriously injured by tipping furniture. You must install the Tipping Restraint Hardware with the unit to prevent the unit from tipping, causing any accidents or damage. The tipping restraint is intended only as a deterrent, they are not a substitute for proper adult supervision. The tipping restraint is not an earthquake restraint. If you wish to add the extra security of earthquake restraints, they must be purchased and installed separately.

Please call for replacement parts or assistance: 1-866-942-5362

Whalen Furniture Manufacturing

Page 8

Factory No. 10944

Care and Maintenance

- Use a soft, clean cloth that will not scratch the surface when dusting.
- Use of furniture polish is not necessary. Should you choose to use polish, test first in an inconspicuous area.
- Using solvents of any kind on your furniture may damage the finish.
- Never use water to clean your furniture as it may cause damage to the finish.
- Always use coasters under beverage glasses and flowerpots.
- Liquid spills should be removed immediately. Using a soft clean cloth, blot the spill gently. Avoid rubbing.
- Always use protective pads under hot dishes and plates. Heat can cause chemical changes that may create spotting within the furniture finish.
- Stains or marks from crayons or ink markers will be difficult to remove.
- In the event that your furniture is stained or otherwise damaged during use, we recommend that you call a professional to repair your furniture.
- Check bolts/screws periodically and tighten them if necessary.

Further advice about furniture care

It is best to keep your furniture in a climate-controlled environment. Extreme temperature and humidity changes can cause fading, warping, shrinking and splitting of wood. It is advised to keep furniture away from direct sunlight as sun may damage the finish.

Proper care and cleaning at home will extend the life of your purchase. Following these important and helpful tips will enhance your furniture as it ages.

We hope you enjoy your purchase for many years.
Thank you for your purchase!

QUALITY GUARANTEE

We are confident that you will be delighted with your Whalen Furniture purchase.

Should this product be defective in workmanship or materials or fail under normal use, we will repair or replace it for up to one (1) year from the date of purchase. Every Whalen Furniture product is designed to meet your highest expectations. We guarantee that you will immediately see the value of our fine furniture.

This warranty gives you specific legal rights and you may also have other rights which vary from State to State (province to province).

Customer Service: 1-866-942-5362
8:30 a.m. - 4:30 p.m. PST, Monday to Friday
www.whalenstyle.com

Please call for replacement parts or assistance: 1-866-942-5362

IF YOU NEED TO ORDER ANY REPLACEMENT PARTS, PLEASE USE THE LIST BELOW

Audio Video Tower (AVT-22E)

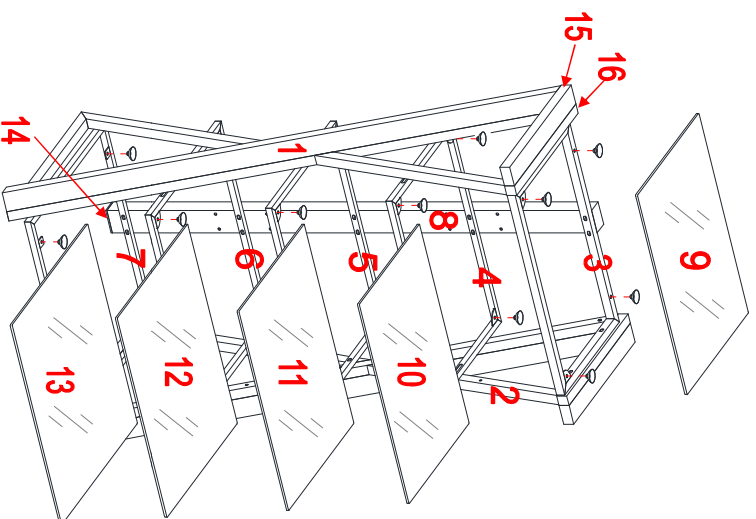

17



18



19

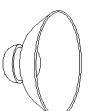

21



23

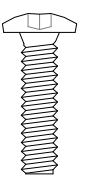

25

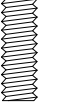
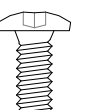

27



29

*AVT-22E-1-LSF	Left Side Frame	*AVT-22E-15-REC	Rectangular End Cap (50 x 25 mm)
*AVT-22E-2-RSF	Right Side Frame	*AVT-22E-16-SEC	Square End Cap (25 x 25 mm)
*AVT-22E-3-TSF	Top Shelf Frame	*AVT-22E-17-CW	Cable Wheel
*AVT-22E-4-MUSF	Middle Upper Shelf Frame	*AVT-22E-18-FL	Floor Leveler
*AVT-22E-5-MSF	Middle Shelf Frame	*AVT-22E-19-OPG	Oval Plastic Grommet
*AVT-22E-6-MLSF	Middle Lower Shelf Frame	*AVT-22E-20-SC	Suction Cup
*AVT-22E-7-BSF	Bottom Shelf Frame	*AVT-22E-21-5/8B	5/8" Bolt
*AVT-22E-8-S	Spine	*AVT-22E-22-1B	1" Bolt
*AVT-22E-9-TG	Top Glass	*AVT-22E-23-1 1/4B	1-1/4" Bolt
*AVT-22E-10-MUGS	Middle Upper Glass Shelf	*AVT-22E-24-LW	Lock Washer
*AVT-22E-11-MGS	Middle Glass Shelf	*AVT-22E-25-FW	Flat Washer
*AVT-22E-12-MLGS	Middle Lower Glass Shelf	*AVT-22E-26-M4AW	4 mm Allen Wrench
*AVT-22E-13-BGS	Bottom Glass Shelf	*AVT-22E-27-TRHK	Tipping Restraint Hardware Kit
*AVT-22E-14-SEC	Spine End Cap (40 x 60 mm)	*AVT-22E-CH	Complete Hardware



LOTE NÚMERO: _____
FECHA DE COMPRA: ___/___/___

Torre de Audio / Video Serie # AVT-22E

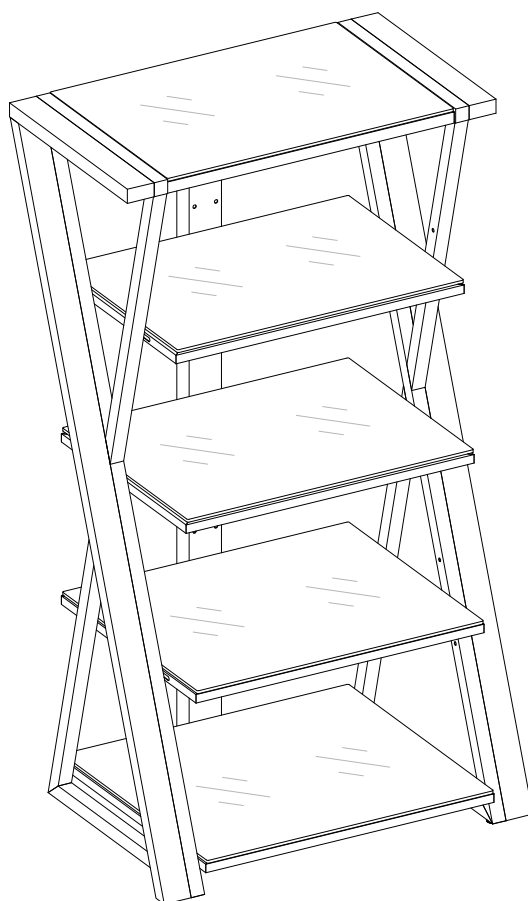

ENSAMBLE REQUERIDO POR ADULTO

Si tienen alguna pregunta acerca del ensamble o si alguna parte está faltante, no retorne este producto a la tienda que lo compro. Por favor llame a nuestro departamento de ayuda al cliente teniendo su instructivo y lista de partes para proveer el modelo, nombre de parte o el número de fábrica:

1-866-942-5362

Hora estándar del Pacífico: 8:30 a.m. - 4:30 p.m., Lunes-Viernes

O visite nuestra página de web 24 horas al día, 7 días a la semana para ayuda en su producto

www.whalenstyle.com

O envíe su requerimiento a parts@whalenfurniture.com

**ESTE INSTRUCTIVO CONTIENE INFORMACIÓN IMPORTANTE DE SEGURIDAD.
POR FAVOR LEA Y MANTENGA EL INSTRUCTIVO PARA USO FUTURO.**

Whalen Furniture Manufacturing

Página 1

Fábrica No. 10944

Fecha: 2015-04-07 Rev. 1 Fábrica: FOCIDI

PESOS MÁXIMOS RECOMENDADOS

FABRICANTE: Whalen Furniture Manufacturing
 CATALOGO: Torre de Audio / Video (AVT-22E)
 FECHA DE MANUFACTURA: Abril 2015
 HECHO EN CHINA

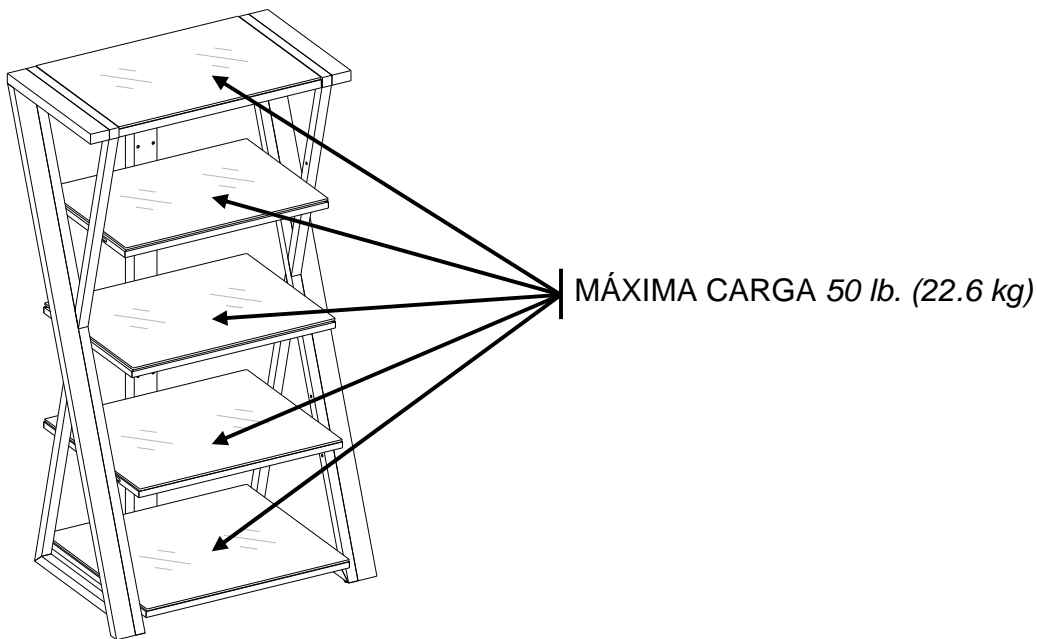

⚠ ADVERTENCIA

ESTA UNIDAD NO DEBE UTILIZARSE CON CARGAS O PESOS MAYORES A LOS INDICADOS. USAR CON CARGAS O PESOS MAYORES DE LOS INDICADOS PUEDE RESULTAR EN INESTABILIDAD, DAÑOS O LESIONES.

INFORMACION GENERAL, RECOMENDACIONES Y TRUCOS

1. Por favor lea el instructivo antes de comenzar el ensamble.
2. Remover todo el herraje de la caja y acomodar por medida.
3. Checar que todo el herraje y partes esten completos ANTES de comenzar el ensamble.
4. Pida ayuda a un amigo para ensamblar esta unidad.
5. Para evitar daños, ensamble esta unidad en una area libre, limpia y nivelada.
6. Espere que todos los pasos se terminen antes de apretar todos los tornillos completamente.
7. Asegurese que todos los tornillos esten bien apretados antes de utilizar al unidad.

Este producto se vende con un Juego Sujetador. Usted debe instalar este Juego Sujetador entre su pared y la torre para prevenir accidentes o daños. Cuando se instala apropiadamente, este puede proteger contra caída inesperadas de la torre debido a temblores, golpes o en caso de subirse en ella. Este Juego sirve solo como un sujetador y no sustituye la supervisión por parte de un adulto. El uso de este tipo de sujetadores pueden prevenir, pero no eliminar la posibilidad de que la unidad se caiga o se incline.

Por favor llame por re-emplazo de parts o asistencia: 1-866-942-5362

Lista de Partes y Artículos de Ferretería

Por favor lea completamente las instrucciones y verifique que estén todas las partes y artículos de ferretería antes de iniciar el ensamble.

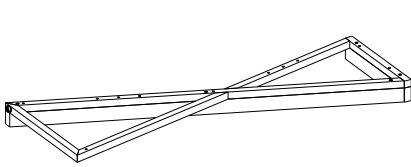

A- Marco izquierdo (1)

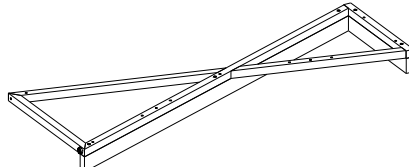

B- Marco derecho (1)

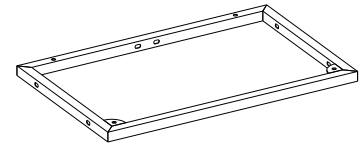

C- Repisa superior (1)

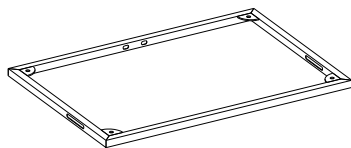

D- Repisa intermedia superior (1)

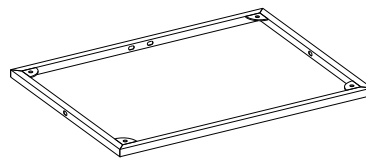

E- Repisa intermedia (1)

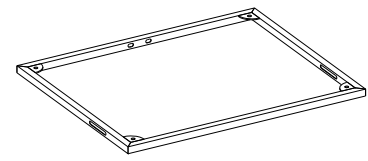

F- Repisa intermedia inferior (1)

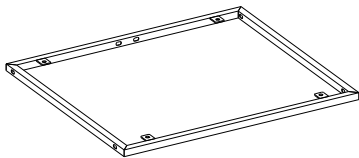

G- Repisa inferior (1)

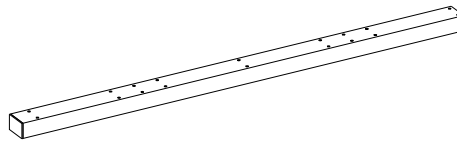

H- Poste (1)

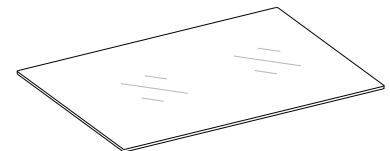

I- Vidrio superior (1)

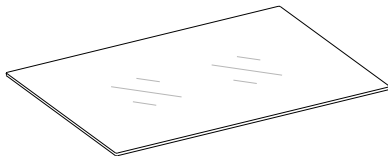

J- Vidrio intermedio superior (1)

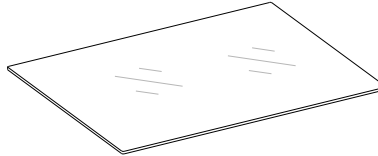

K- Vidrio intermedio (1)

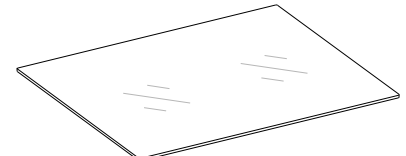

L- Vidrio intermedio inferior (1)

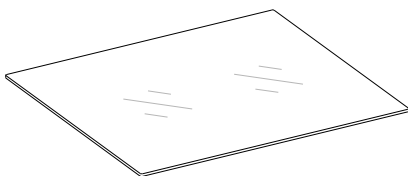

M- Vidrio inferior (1)

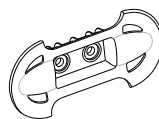

N- Guía para cable (2)

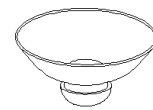

(1) Ventosa (20+1 extra)

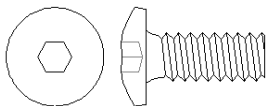

(2) Tornillo de 5/8" (4+1 extra)

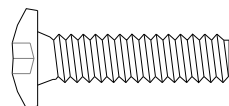

(3) Tornillo de 1" (18+1 extra)

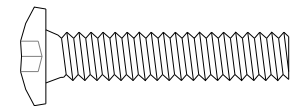

(4) Tornillo de 1-1/4" (6+1 extra)



(5) Arandela presión (6+1 extra)

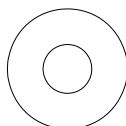

(6) Arandela plana (6+1 extra)

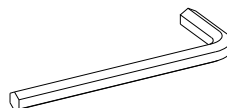

Llave Allen M4 (2)

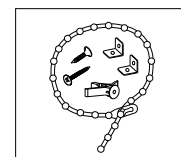

Juego de restricción de movimiento (1)
(Dentro bolsa de plástico)

Herramienta requerida: Llave Allen (proveida) y desarmador estrella (no proveido).

Por favor llame por re-emplazo de parts o asistencia: 1-866-942-5362

Instrucciones de ensamble

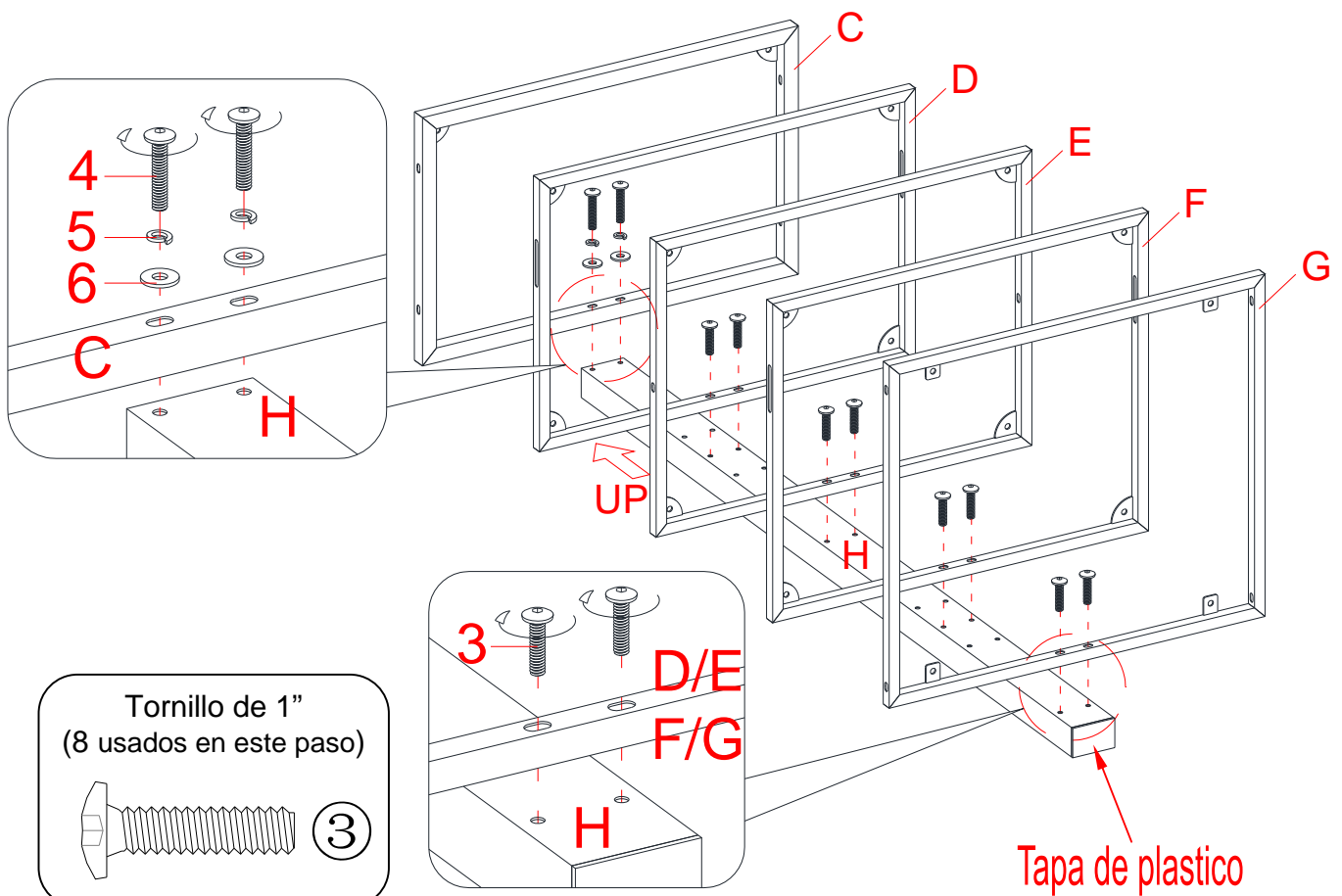

Tornillo de 1"
(8 usados en este paso)

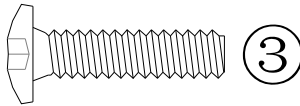

Tornillo de 1-1/4"
(2 usados en este paso)

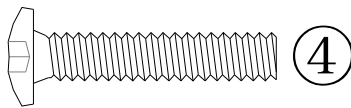

Arandela presión
(2 usados en este paso)



Arandela plana
(2 usados en este paso)

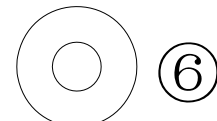

NOTA: *Por favor no apriete completamente todos los tornillos, hasta que termine con el ensamble de las partes, después asegure completamente todos los tornillos, ésto lo hará más fácil durante el ensamble.*

1. Desempacar la unidad y confirmar que se tiene todo el herraje y partes requeridas.
2. Poner el poste (H) hacia abajo sobre una superficie lisa, como se muestra.
3. Alinear y fijar las repisas (C, D, E, F y G) al poste (H), como se muestra. Cerciorarse que los soportes internos de las repisas apuntan hacia arriba despues del ensamble.

Por favor llame por re-emplazo de parts o asistencia: 1-866-942-5362

Whalen Furniture Manufacturing

Página 4

Fábrica No. 10944

Instrucciones de ensamble

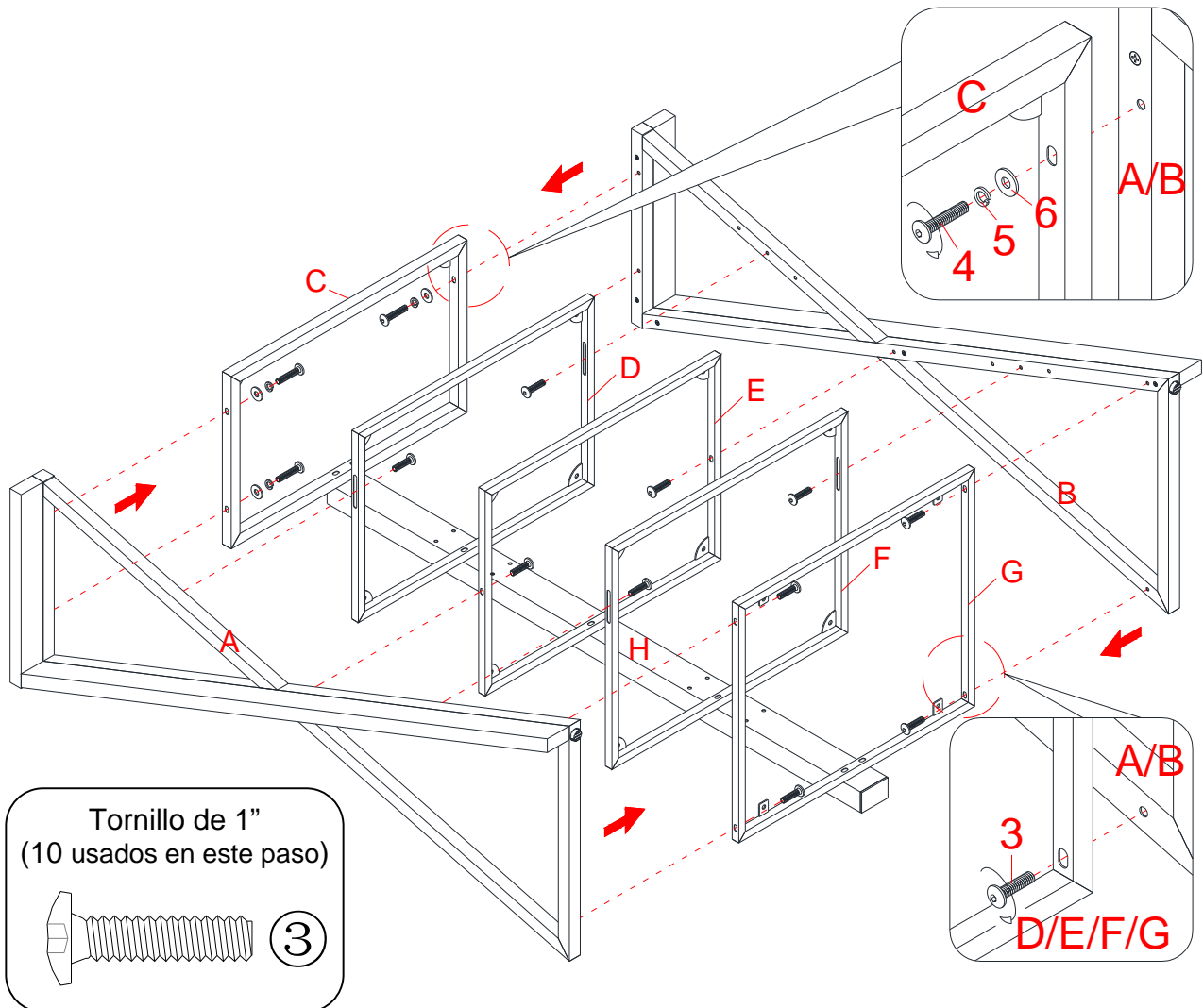

Tornillo de 1"
(10 usados en este paso)

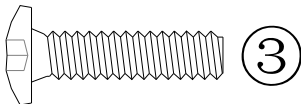

Tornillo de 1-1/4"
(4 usados en este paso)

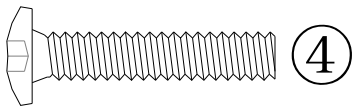

Arandela presión
(4 usados en este paso)



Arandela plana
(4 usados en este paso)

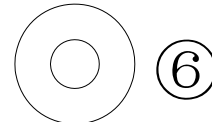

4. Alinear y adjuntar el marco de la izquierda (A) a las repisas (C, D, E, F y G), tal como se muestra. No apretar los tornillos.
5. Repita el mismo procedimiento para colocar el marco de la derecha (B) en el extremo opuesto.
6. Vuelva y apriete todos los tornillos. Pida ayuda a soportar la unidad en posición vertical.

Instrucciones de ensamble

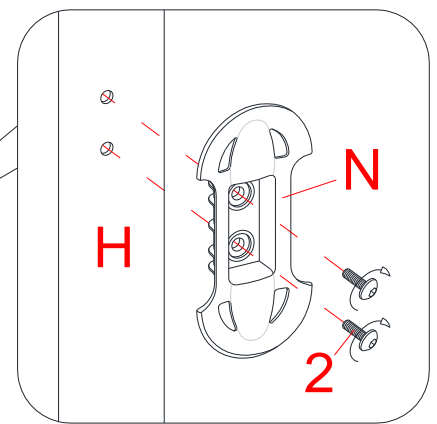
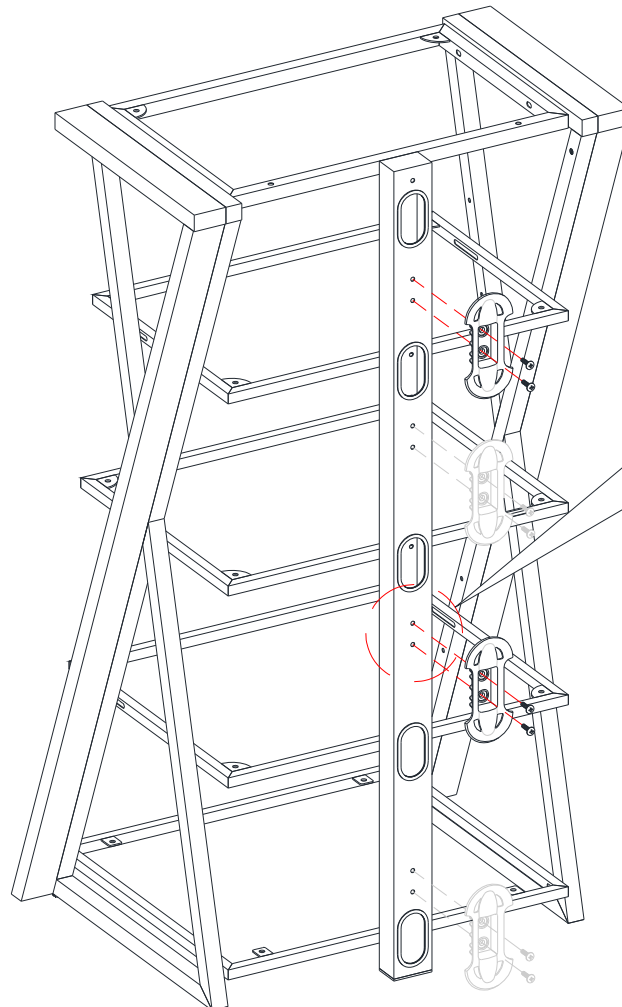
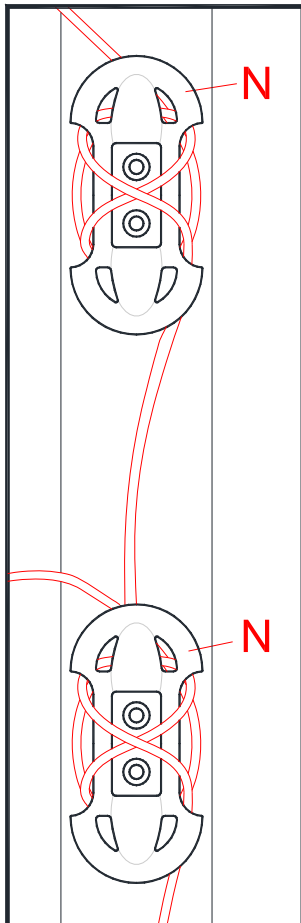

Vista posterior

Tornillo de 5/8"
(4 usados en este paso)

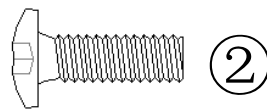

7. Fijar 2 guías para cable (N) a la parte posterior del poste (H) y apretar con la llave Allen proveida.
8. Usted puede usar controles de cables para ayudar a mantener los cables de su centro de entretenimiento y cables organizados.

Instrucciones de ensamble

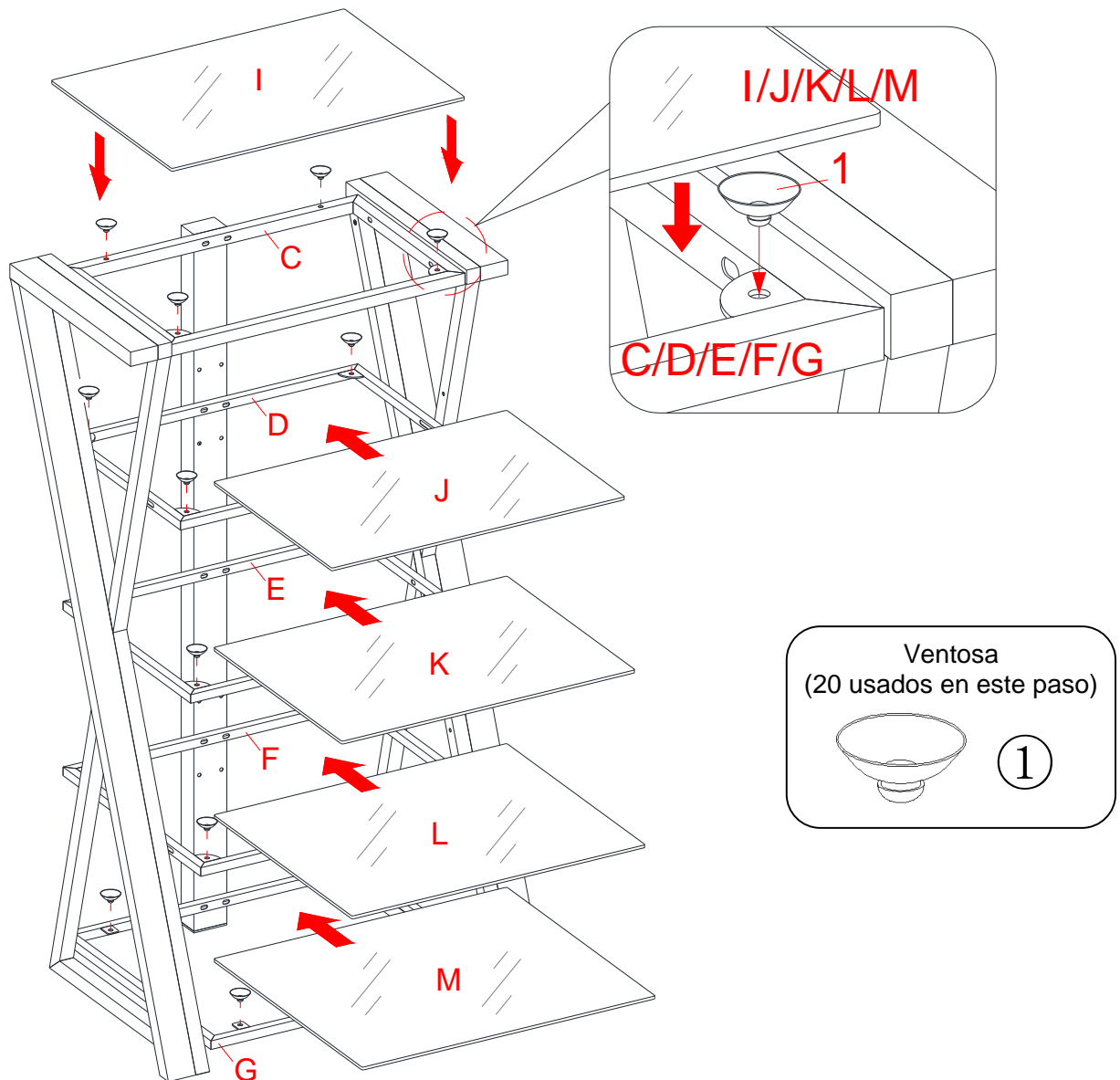

9. Ponga ventosas (1) firmemente en las lengüetas de metal y dentro de las placas de esquina en las repisas (C, D, E, F y G).

CONSEJO: Si una ventosa se resiste a la inserción, trate de presionar en el centro de la copa con la llave Allen mientras gira hacia la derecha en el agujero.

10. Coloque los vidrios (I, J, K, L y M) en el lugar, partiendo por el vidrio inferior (M). Asegúrese de que el vidrio está bien centrado y el lado negro del vidrio queda hacia abajo. Empuje cada vidrio hasta el fondo en contra del poste.

NOTA: Si el vidrio está rayado se puede minimizar el daño mediante el uso de un marcador NEGRO para el relleno en el área rayada por debajo.

Por favor llame por reemplazo de parts o asistencia: 1-866-942-5362

Whalen Furniture Manufacturing

Página 7

Fábrica No. 10944

Instrucciones de ensamble

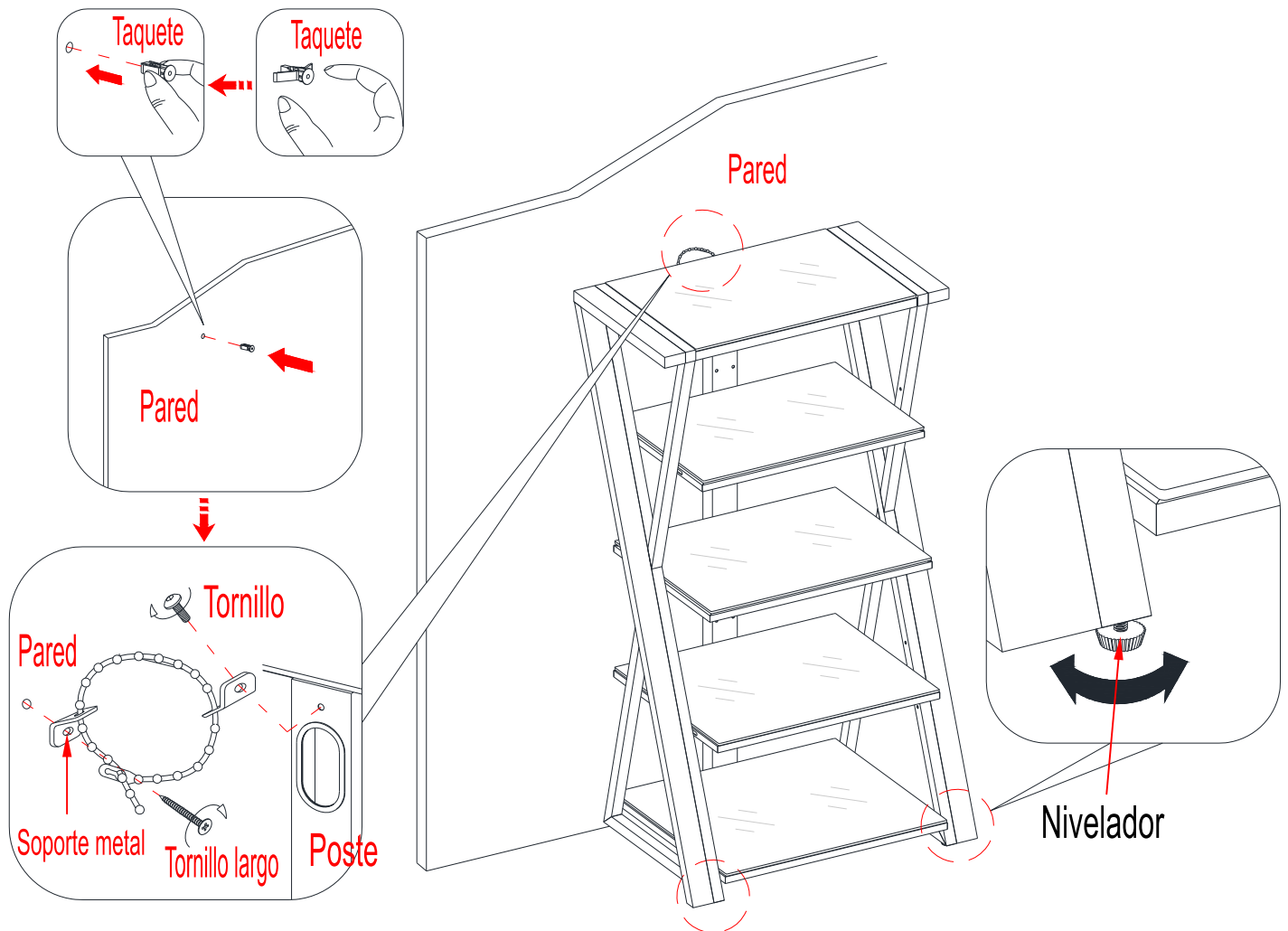

Herramienta requerida: Llave Allen (proveído), desarmador estrella, Mazo, Taladro, y broca de 3/8".

11. Coloque la torre montada en la ubicación deseada contra una pared. Si es necesario, ajuste los niveladores de piso pre-conectados en la parte inferior de las patas (A y B) para nivelar la unidad.
12. A continuación, siga las instrucciones impresas en la bolsa de plástico que contiene el herraje para restricción de movimiento para fijar al poste (H) y la pared.

NOTA: Los niños pequeños pueden ser gravemente heridos por los muebles de inflexión. Debe instalar el juego de restricción de movimiento en la unidad para evitar que la unidad se vuelque, provocando accidentes o daños. Las restricciones se ofrecen solamente como un elemento de disuasión, no son un sustituto de la supervisión de un adulto. Las restricciones de inflexión no son restricciones para terremotos. Si desea añadir la seguridad adicional de las restricciones del terremoto, deben ser adquiridos e instalados por separado.

Por favor llame por reemplazo de parts o asistencia: 1-866-942-5362

Whalen Furniture Manufacturing

Página 8

Fábrica No. 10944

Mantenimiento y Cuidados

- Use una toalla suave y limpia para evitar daños y rayaduras.
- Uso de cera para pulir muebles no es necesario. Si desea usar cera cheque en una area que no sea visible para checar su funcionamiento.
- Usar solventes de cualquier tipo puede dañar el terminado del mueble.
- Nunca use agua para limpiar la unidad, ya que le puede dañar el terminado.
- Siempre utilice protección para vasos cuando ponga sobre la unidad.
- Líquidos derramados deben limpiarse inmediatamente, con una toalla suave evitando tallar.
- Siempre utilizar protectores en caso de poner cosas calientes. El calor puede provocar una reacción química en el terminado y dañarlo.
- Manchas o marcas de crayones serán difíciles de remover.
- En caso que su unidad sea manchada durante el uso le recomendamos hablar a un profesional para que le ayude.
- Checar tornillos periódicamente y apretar en caso necesario.

Más recomendaciones para el cuidado de su Mueble

Es lo mejor mantener la unidad en una area de clima controlado. Temperatura extrema y cambios de humedad pueden causar cambios como partes pandas, molduras que se contraigan o que la madera se raje. Es recomendable mantener la unidad lejos del sol directo ya que puede dañar el terminado.

Cuidados adecuados y limpieza pueden extender la vida útil de su unidad. Siga estas recomendaciones y mantendrá su mueble en buenas condiciones de uso por muchos años.

Esperamos que disfrute de su compra durante muchos años.
Gracias por su compra!

GARANTÍA DE CALIDAD

Estamos seguros de que usted estará encantado con su compra Whalen Furniture. Si este producto presenta defectos de fabricación ni de materiales o no en condiciones de uso normal, que la repararemos o sustituiremos por hasta un (1) año desde la fecha de compra. Cada producto Whalen Furniture está diseñado para satisfacer sus más altas expectativas. Le garantizamos que usted verá inmediatamente el valor de los muebles finos.

Esta garantía le otorga derechos legales específicos y usted también puede tener otros derechos que varían de un estado a otro (una provincia a otra).

Servicio al cliente: 1-866-942-5362
08:30 a.m. - 16:30 p.m., PST, de lunes a viernes
www.whalenstyle.com

Por favor llame por re-emplazo de parts o asistencia: 1-866-942-5362

SI REQUIERE ORDENAR PARTES, UTILIZAR POR FAVOR LA LISTA INFERIOR
Torre de Audio / Video (AVT-22E)

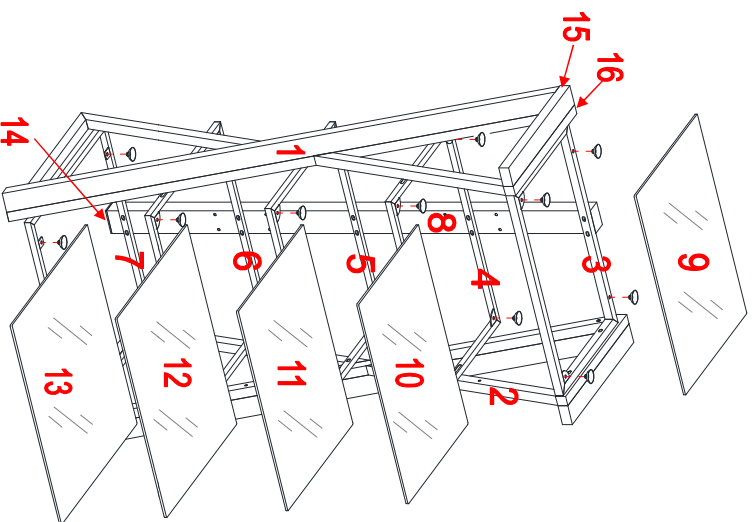

17



18



19

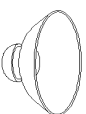

20

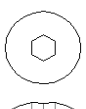

21

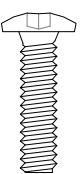
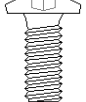

22

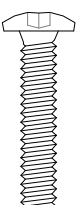

23



24



25



26



27

*AVT-22E-1-LSF	Marco izquierdo	*AVT-22E-15-REC	Tapa de plástico rectangular (50 x 25 mm)
*AVT-22E-2-RSF	Marco derecho	*AVT-22E-16-SEC	Tapa de plástico cuadrado (25 x 25 mm)
*AVT-22E-3-TSF	Repisa superior	*AVT-22E-17-CW	Guía para cable
*AVT-22E-4-MUSF	Repisa intermedia superior	*AVT-22E-18-FL	Nivelador
*AVT-22E-5-MSF	Repisa intermedia	*AVT-22E-19-OPG	Ojal de plástico ovalado
*AVT-22E-6-MLSF	Repisa intermedia inferior	*AVT-22E-20-SC	Ventosa
*AVT-22E-7-BSF	Repisa inferior	*AVT-22E-21-5/8B	Tornillo de 5/8"
*AVT-22E-8-S	Poste	*AVT-22E-22-1B	Tornillo de 5/8"
*AVT-22E-9-TG	Vidrio superior	*AVT-22E-23-1 1/4B	Tornillo de 1-1/4"
*AVT-22E-10-MUGS	Vidrio intermedio superior	*AVT-22E-24-LW	Arandela presión
*AVT-22E-11-MGS	Vidrio intermedio	*AVT-22E-25-FW	Arandela plana
*AVT-22E-12-MLGS	Vidrio intermedio inferior	*AVT-22E-26-M4AW	Llave Allen 4 mm
*AVT-22E-13-BGS	Vidrio inferior	*AVT-22E-27-TRHK	Juego de restricción de movimiento
*AVT-22E-14-SEC	Tapa de plástico de poste (40 x 60 mm)	*AVT-22E-CH	Herraje completo